



5-year warranty

Type overview

Type	DN
G220B-J	20

Technical data

Functional data	Valve size [mm]	0.75" [20]
	Fluid	chilled or hot water, up to 60% glycol, steam
	Fluid Temp Range (water)	20...280°F [-7...138°C]
	Body Pressure Rating	ANSI Class 250, up to 400 psi below 150°F
	Flow characteristic	modified equal percentage
	Servicing	repack kits available
	Rangeability Sv	100:1
	Max Differential Pressure (Steam)	20 psi [103 kPa]
	Flow Pattern	2-way
	Leakage rate	ANSI Class VI
	Controllable flow range	stem up - open A – AB
	Cv	5.5
	Maximum Inlet Pressure (Steam)	35 psi [241 kPa]
Materials	Valve body	Bronze
	Valve plug	brass
	Spindle	stainless steel
	Spindle seal	EPDM O-ring
	Seat	Bronze
	Pipe connection	NPT female ends
Suitable actuators	Non-Spring	LVB(X)
	Spring	LF
	Electrical fail-safe	LVKB(X)

Safety notes

- **WARNING:** This product can expose you to lead which is known to the State of California to cause cancer and reproductive harm. For more information go to www.p65warnings.ca.gov
- The valve has been designed for use in stationary heating, ventilation and air-conditioning systems and must not be used outside the specified field of application, especially in aircraft or in any other airborne means of transport.
- Only authorized specialists may carry out installation. All applicable legal or institutional installation regulations must be complied during installation.
- The valve does not contain any parts that can be replaced or repaired by the user.
- When determining the flow rate characteristic of controlled devices, the recognised directives must be observed.

Installation notes

Flow direction The direction of flow, specified by an arrow on the housing, is to be complied with, since otherwise the valve could become damaged.



Dimensions

Type	DN
G220B-J	20



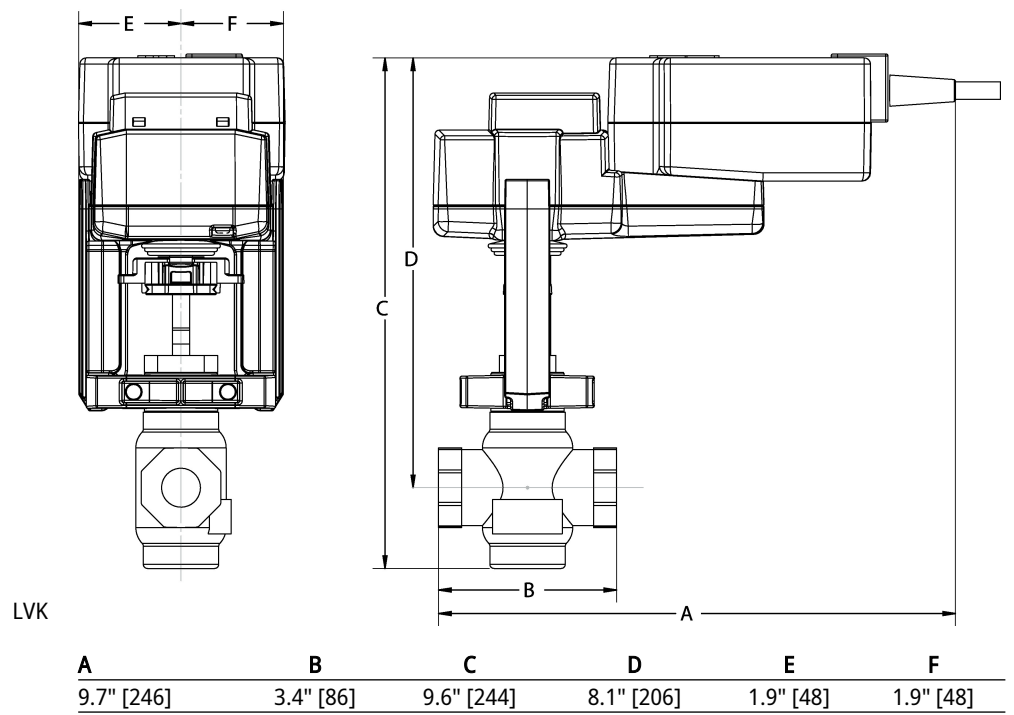



5-year warranty



Technical data

Electrical data	Nominal voltage	AC/DC 24 V
	Nominal voltage frequency	50/60 Hz
	Nominal voltage range	AC 19.2...28.8 V / DC 21.6...28.8 V
	Power consumption in operation	2.5 W
	Power consumption in rest position	1 W
	Transformer sizing	5 VA
	Electrical Connection	18 GA plenum cable, 1 m, with 1/2" conduit connector
	Overload Protection	electronic throughout 0...95° rotation
Functional data	Operating range Y	2...10 V
	Operating range Y note	4...20 mA w/ ZG-R01 (500 Ω, 1/4 W resistor)
	Input Impedance	100 kΩ for 2...10 V (0.1 mA), 500 Ω for 4...20 mA
	Position feedback U	2...10 V
	Position feedback U note	Max. 0.7 mA
	Direction of motion motor	selectable with switch 0/1
	Direction of motion fail-safe	reversible with cw/ccw mounting
	Angle of rotation	90°
	Running Time (Motor)	150 s / 90°
	Running time motor note	constant, independent of load
	Running time fail-safe	<25 s @ -4...122°F [-20...50°C], <60 s @ -22°F [-30°C]
	Noise level, motor	50 dB(A)
	Noise level, fail-safe	62 dB(A)
Position indication	Mechanical	
Safety data	Power source UL	Class 2 Supply
	Degree of protection IEC/EN	IP54
	Degree of protection NEMA/UL	NEMA 2
	Enclosure	UL Enclosure Type 2
	Agency Listing	cULus acc. To UL 873 and CAN/CSA C22.2 No. 24-93
	Quality Standard	ISO 9001
	UL 2043 Compliant	Suitable for use in air plenums per Section 300.22(C) of the NEC and Section 602 of the IMC
	Ambient humidity	Max. 95% RH, non-condensing
	Ambient temperature	-22...122°F [-30...50°C]
	Storage temperature	-40...176°F [-40...80°C]
	Servicing	maintenance-free
Weight	Weight	3.4 lb [1.5 kg]
	Materials	Housing material

Footnotes †Rated Impulse Voltage 800V, Type of action 1.AA, Control Pollution Degree 3

Electrical installation

✂ INSTALLATION NOTES

- (A)** Actuators with appliance cables are numbered.
- (1)** Provide overload protection and disconnect as required.
- (3)** Actuators may also be powered by DC 24 V.
- (5)** Only connect common to negative (-) leg of control circuits.
- (7)** A 500 Ω resistor (ZG-R01) converts the 4...20 mA control signal to 2...10 V.
- (11)** Actuators may be connected in parallel if not mechanically linked. Power consumption and input impedance must be observed.
- ◆** Meets cULus requirements without the need of an electrical ground connection.
- (1) Warning! Live electrical components!**
During installation, testing, servicing and troubleshooting of this product, it may be necessary to work with live electrical components. Have a qualified licensed electrician or other individual who has been properly trained in handling live electrical components perform these tasks. Failure to follow all electrical safety precautions when exposed to live electrical components could result in death or serious injury.

Wiring diagrams

2...10 V / 4...20 mA Control

